

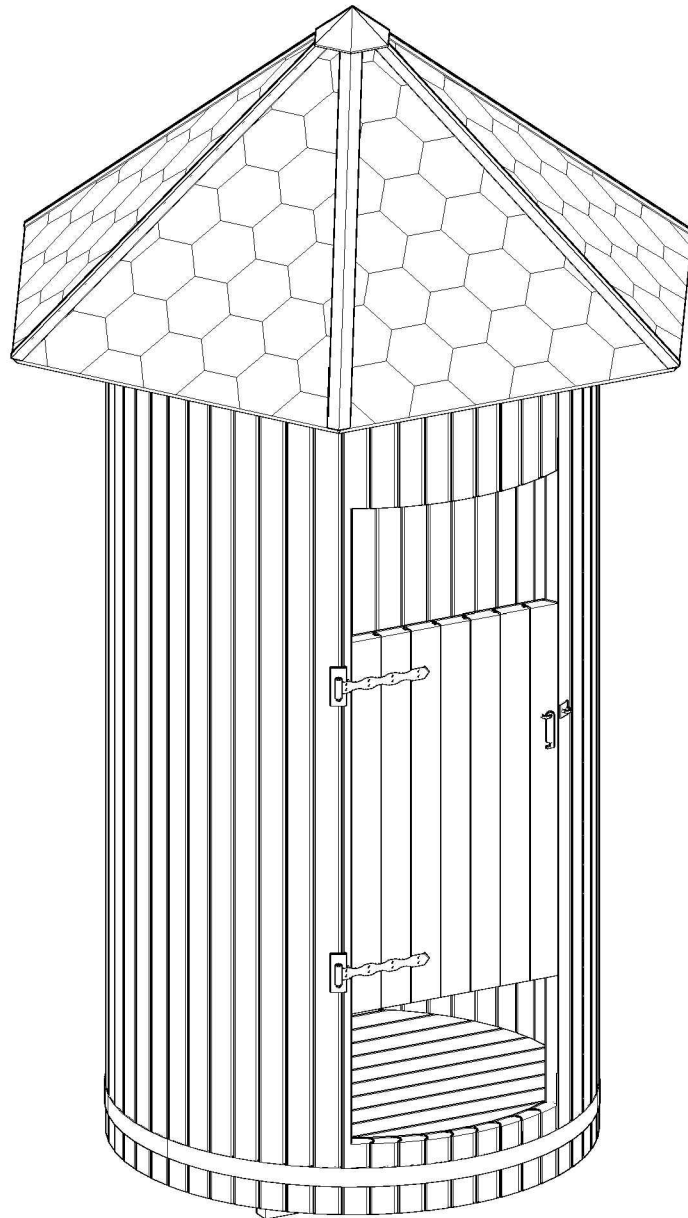

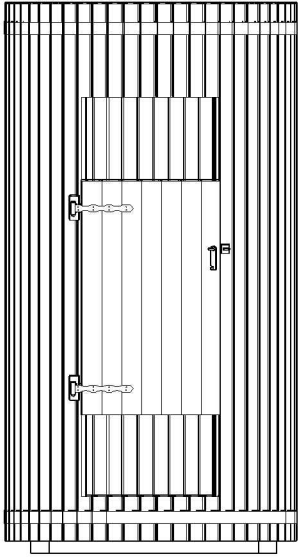

# Shower

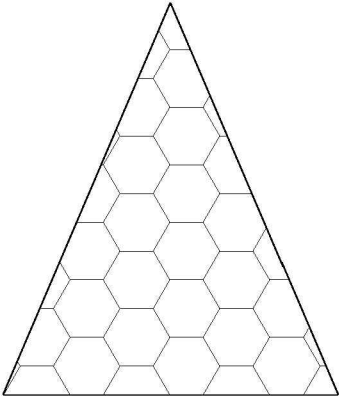

1. SHOWER

No.	Detail	Pcs	
1		1	
2		6	
3		6	



# 1. Shower

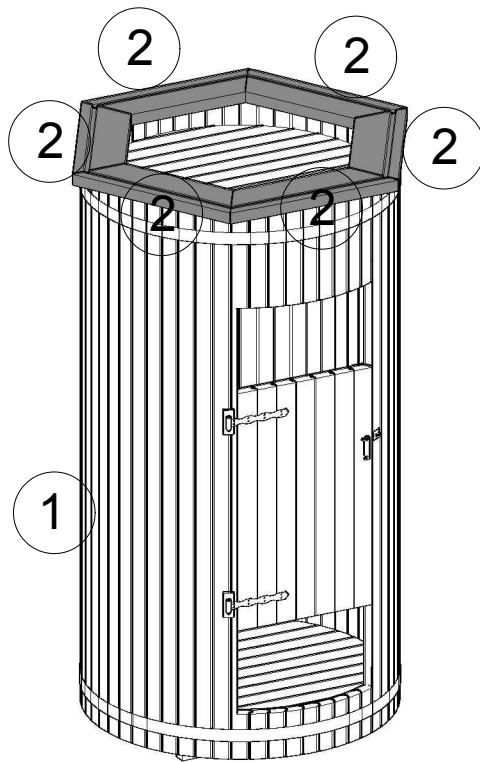

1

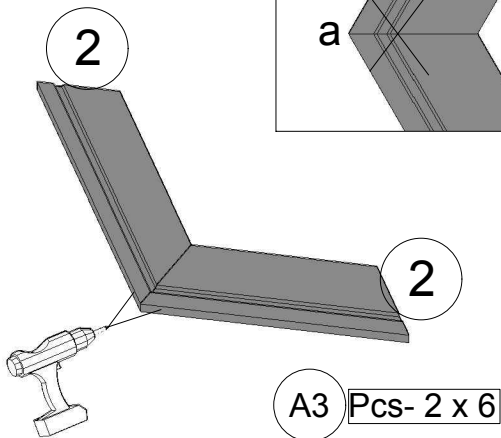

3

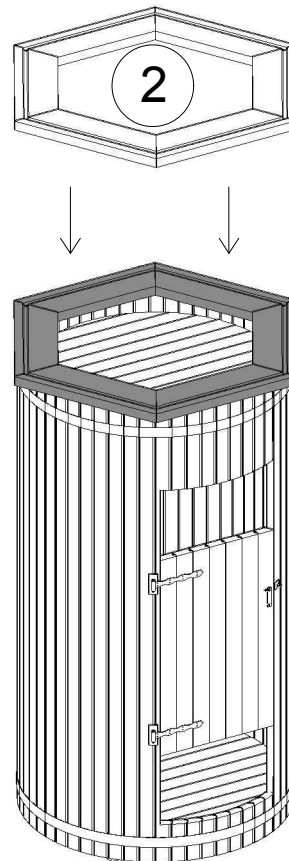

4

A3 Pcs- 8

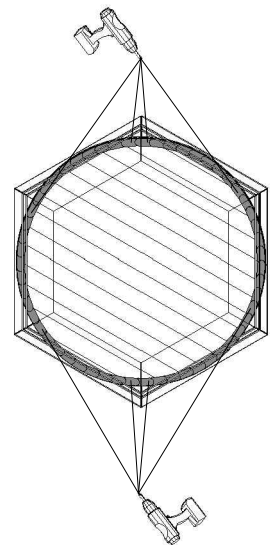

2

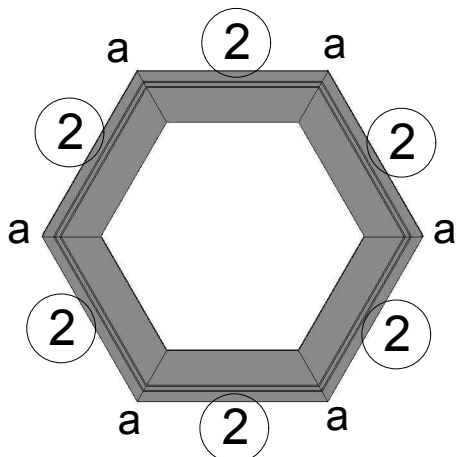

## 2. Shower

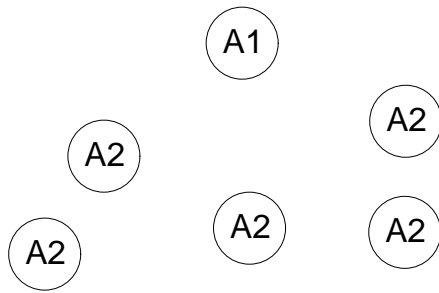

3

1

3

3

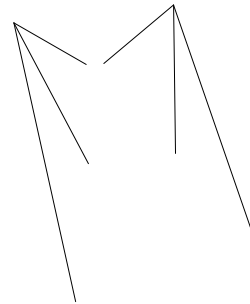

2

3

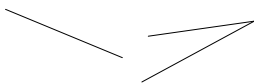

A5 Pcs- 3 x 6

3

4

A2

A10

A1

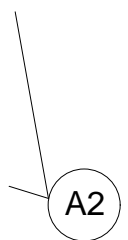
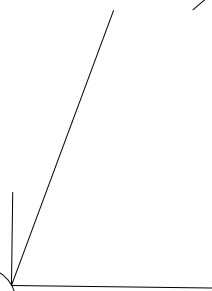

A2