

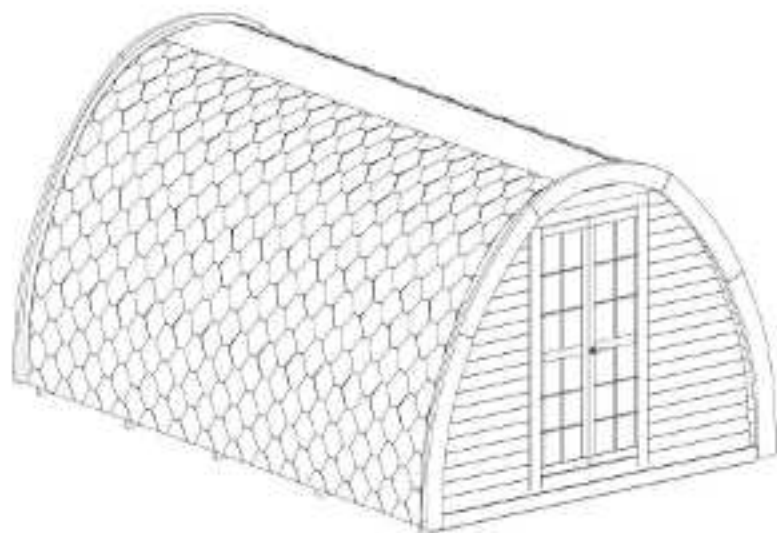





























# NOTICE DE MONTAGE

## MEGA POD ISOLE 4,80 m X 3,20

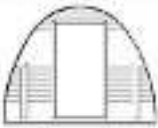
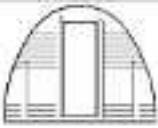
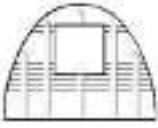

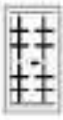
HETALA' VENTURE LOISIRS  
HEBERGEMENTS INSOLITES NATURELS

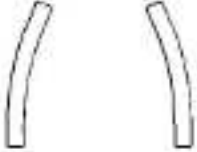
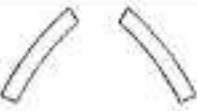
No.	$\begin{matrix} x \\ y \\ z \end{matrix}$	Detail	Pec.	Dimension (x,y,z) mm
1			4	
2			14	
3			15	
4			1	
5			22	
6			22	
4.1			1	
7			1	
8			61	
9			2	
10			24	
11			6	
12			52	
13			22	
14			28	
15			1	
16			1	
17			2	
18			1	
19			2	
20			1	
21			—	
22			2	

No.	$\begin{matrix} x & z \\ y \end{matrix}$	Detail	Psc.	Dimension (x,y,z) mm
A			1	
A1			1	
A2			1	
A3			1	
A4			1	
A5			1	
A6			2	
A7			4	
A8			4	
A9			2	
A10			2	



# 1. Insulated Camping Pod 4.8

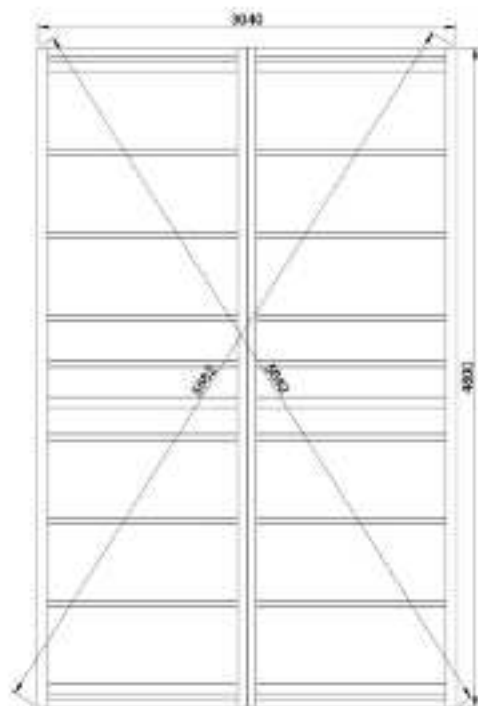

## 2. Insulated Sampling F 50 4.0

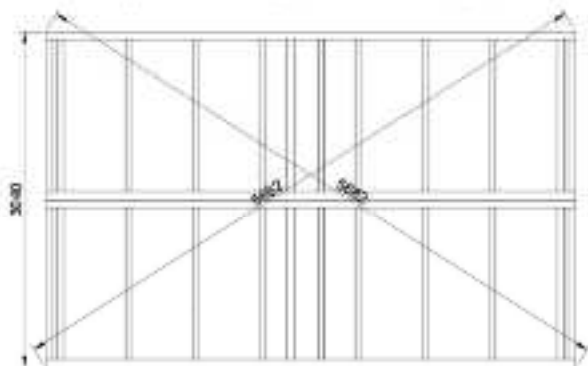
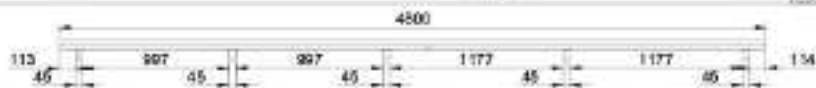
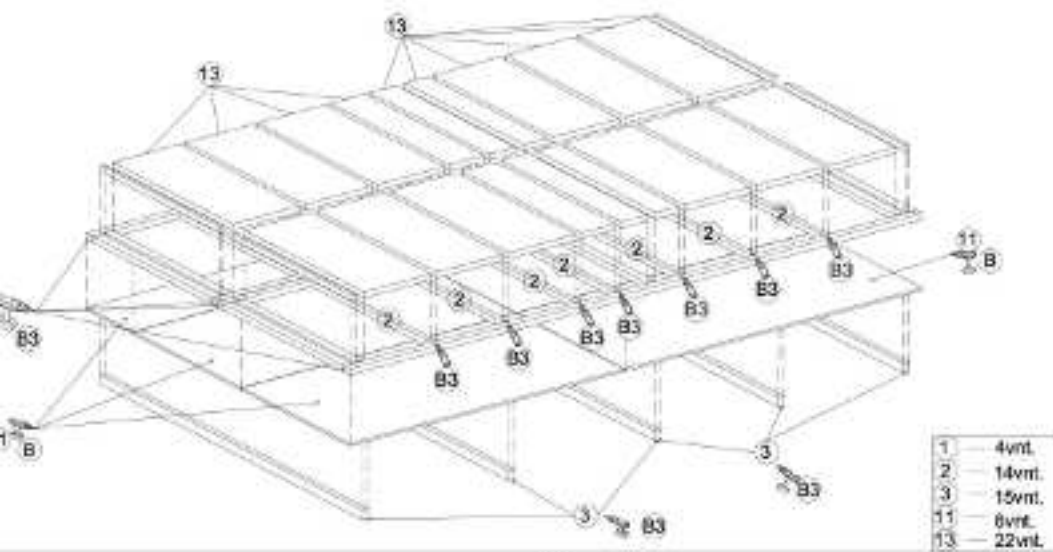

### 3. Insulated Camping Pod 4.8

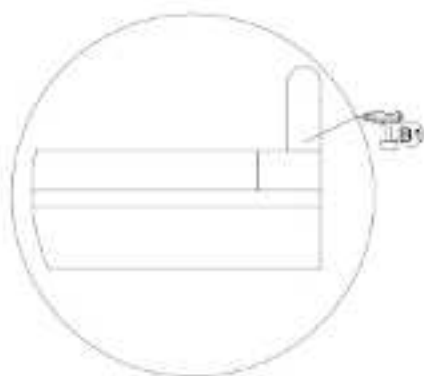
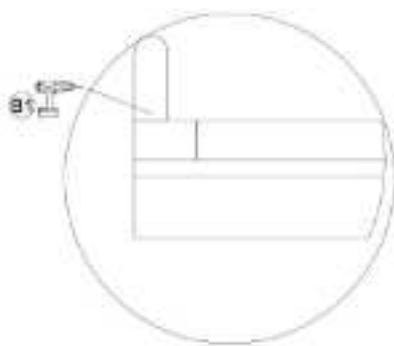
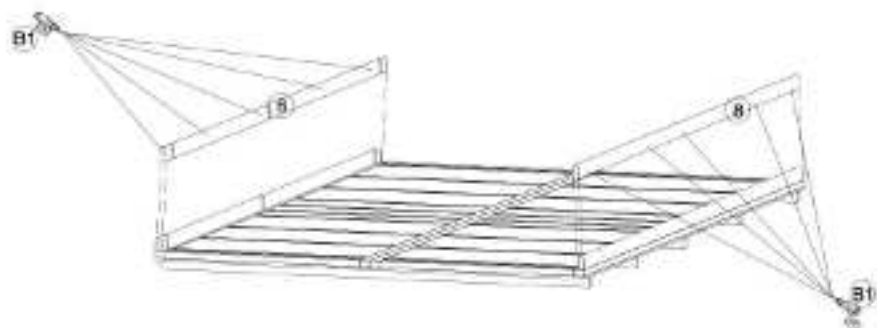

#### 4. Insulated Camping Pod 4.8

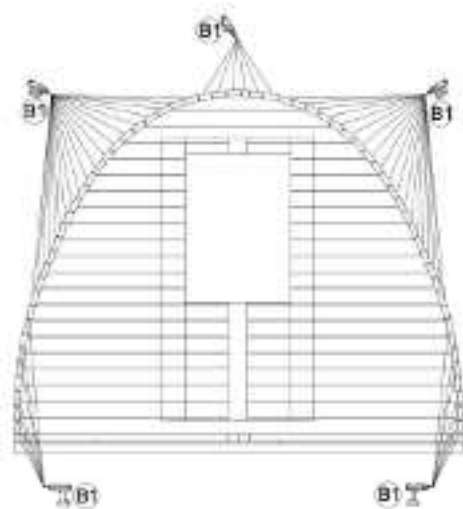
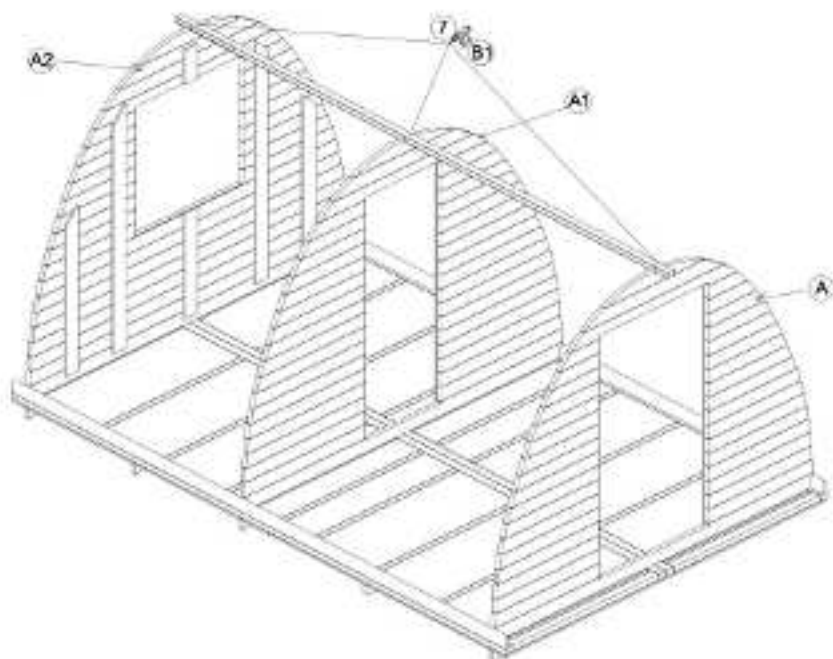

2.

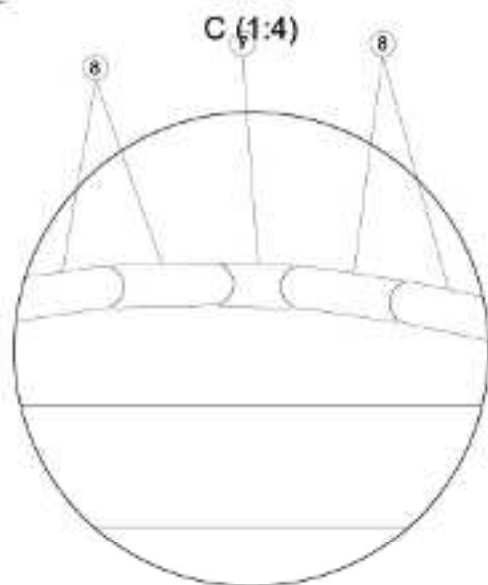



## 5. Insulated Camping Pod 4.8



2.

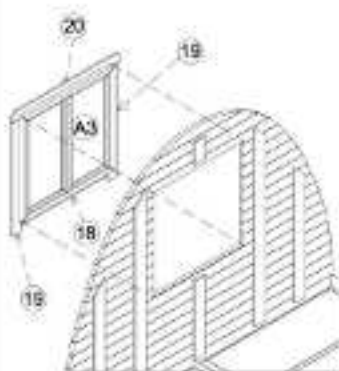

3.

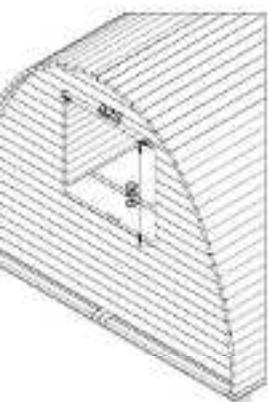

## 6. Insulated Camping Pod 4.8



- |   |          |     |         |
|---|----------|-----|---------|
| 5 | — 22vnt. | 4   | — 1vnt. |
| 6 | — 22vnt. | 4.1 | —       |

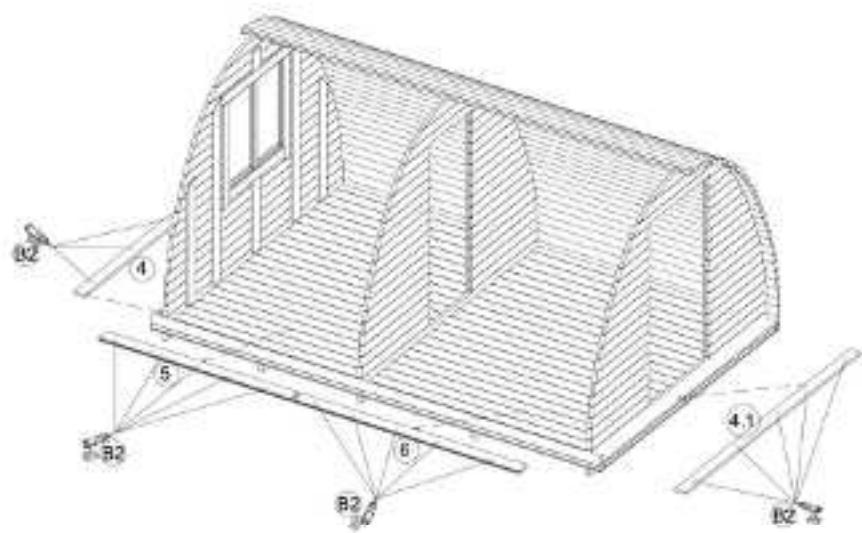

## 7. Insulated Camping Pod 4.8



10	24vnt.	14	26vnt.
9	2vnt.		
12	52vnt.	A11	14.6m <sup>2</sup>

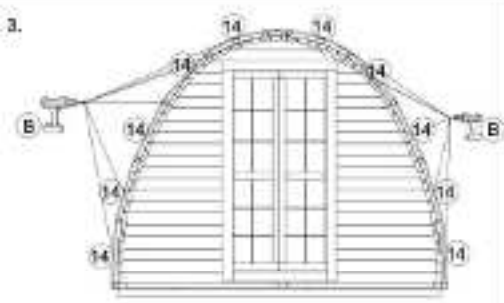
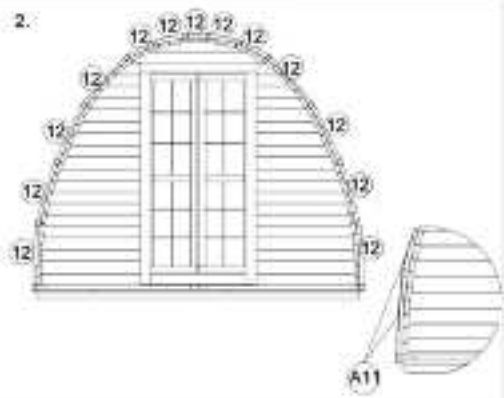
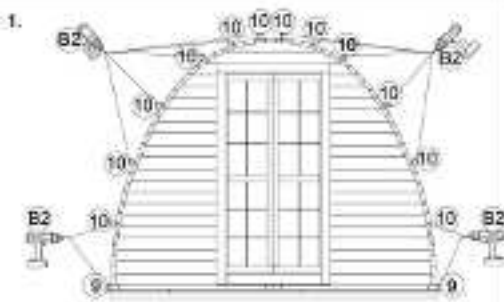

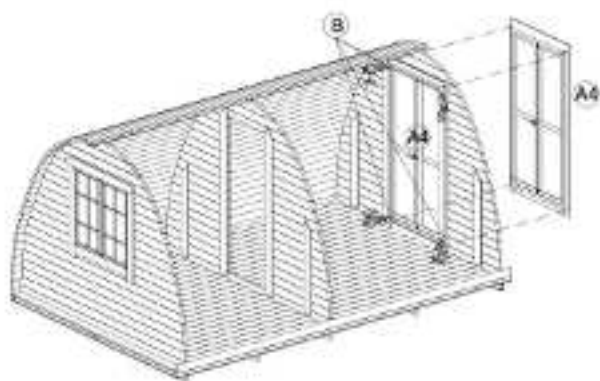

- A4 — 1vnt.
- A13 — 8vnt.
- A10 — 2vnt.

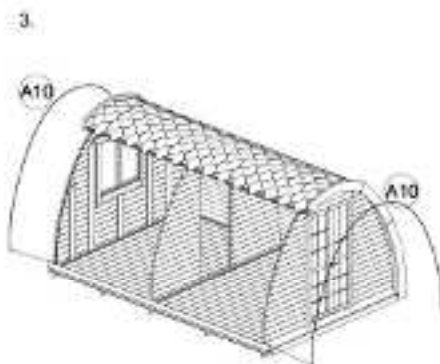
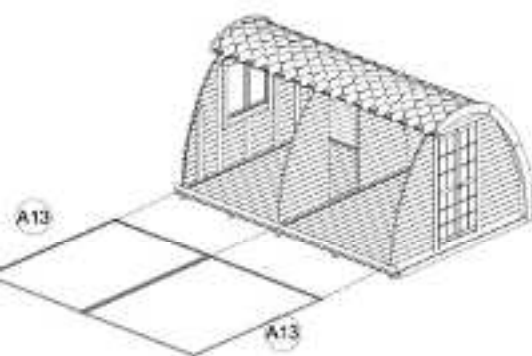

9. Insulated Camping Pod 4.8

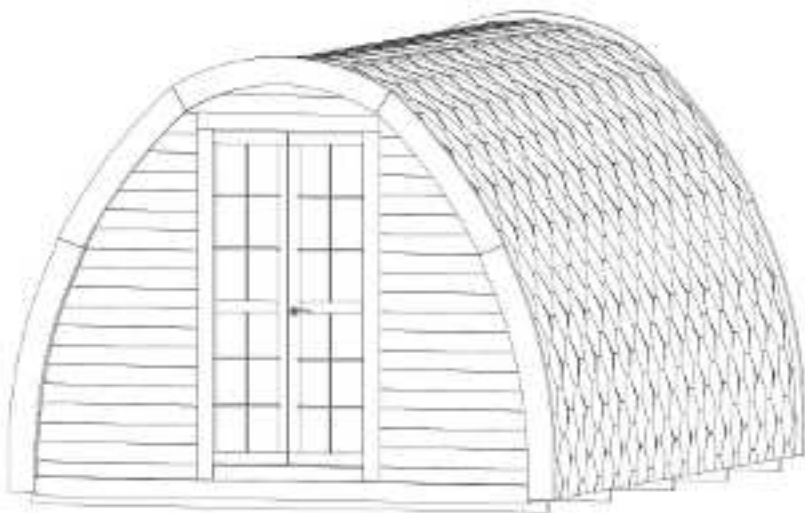

- |     |        |    |   |
|-----|--------|----|---|
| B1  | 220vnt | A9 | — |
| A12 | 2vnt   | A8 | — |
| A7  | 4vnt   | A6 | — |



2.

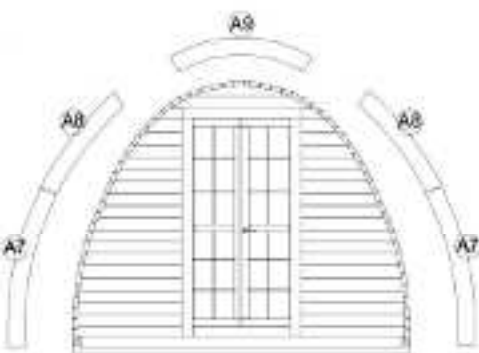

4.



1.

## 10. Insulated Camping Pod 4.8

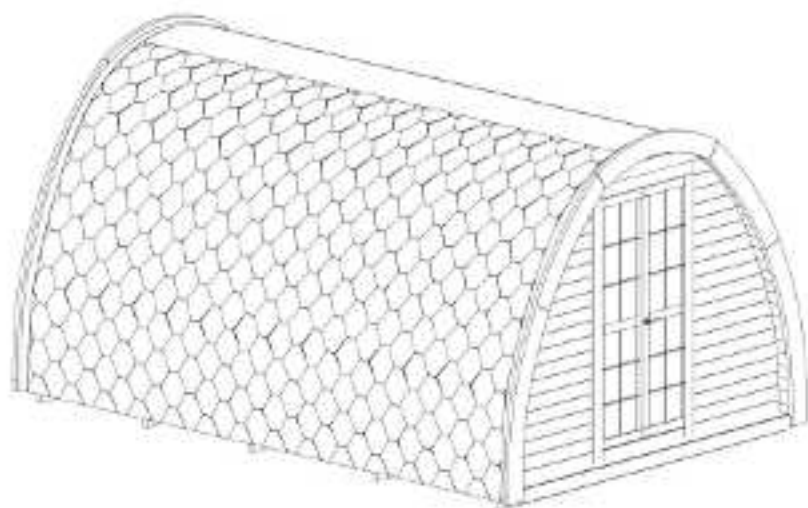

A6 2mt  
A5 1mt

2.

